

# HSF

**NOTES:**

- Current Rating:  
24A(2PIN); 23A(3PIN); 22A(4PIN)[Wire range: 12AWG];
- Voltage Rating: 600V AC/DC;
- Contact Resistance: 5mΩ Max;
- Withstand Voltage: 2500V AC;
- Insulation Resistance: 1000MΩ Min;
- Operating Temperature: -55°C to +105°C;
- Insulator Material: PBT,G.F,UL94V-0,BK;
- Contact Material: Copper Alloy;
- Contact plating:  
W4: 15μ" Gold on contact area (See ordering information),  
100μ" Matte TIN on solder area,  
50μ" Nickel underplating overall;
- Recommended process:  
Wavesolder, Peak temperature: 260±5°C, 5s ;

## Ordering Information

WD6350-1 WS XX W4 B T O X

1=Single Row

WS=180°DIP

No. of Pins:

02=2P; 03=3P; 04=4P

Contact Plating:

W4=15μ" Gold/Matte Sn

Color:

B=Black

T=Tube

0=Standard type

CODE OF KEYING

1=X; 2=Y

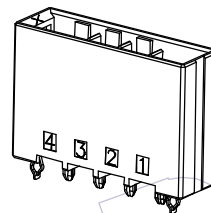
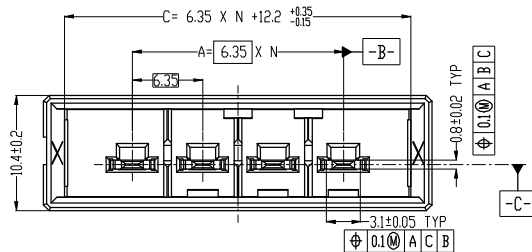

Recommended P.C.B Layout(Top Side)  
PCB THICKNESS: 1.6 ~ 2.4±0.1  
(PCB BOARD TOLERANCE±0.05)

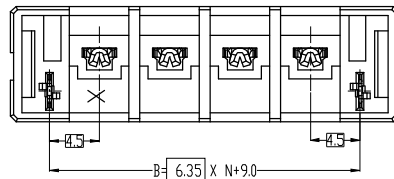
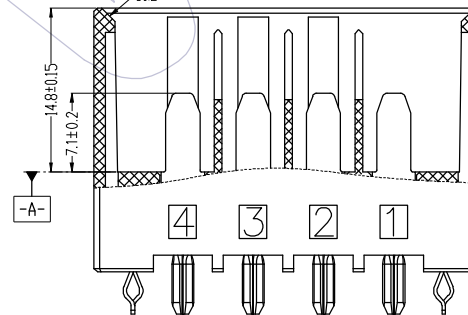
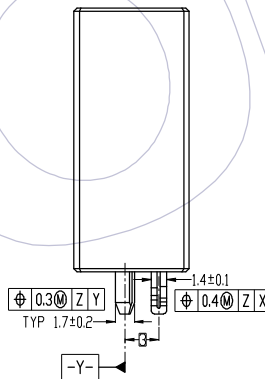
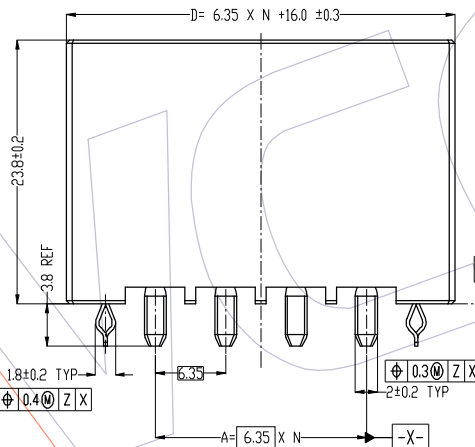
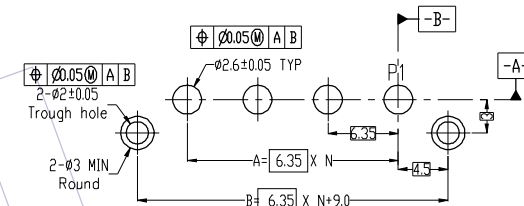

PIN	N	A	B	C	D	PART NO	KEY	KEY LOCATION
2	1	6.35	15.35	18.55	22.35	WD6350-1WS02W4BT01	X	
						WD6350-1WS02W4BT02	Y	
3	2	12.7	21.7	24.9	28.7	WD6350-1WS03W4BT01	X	
						WD6350-1WS03W4BT02	Y	
4	3	19.05	28.05	31.25	35.05	WD6350-1WS04W4BT01	X	
						WD6350-1WS04W4BT02	Y	

REV	DATE	MODIFICATION DESCRIPTION	CHANGE	OPERATION	DRAW	DATE	SCALE	FIT	PART NO.
				X.X	Houfu Peng	2021. 06. 02	UNIT	mm	WD6350-1WSXXW4BT0X
				X.XX	CHECK	DATE	SIZE	A4	TITLE: 6.35mm DYN. Type
A0	2021. 06. 02	NEW		X.XXX	APPROVE	DATE	SHEET	1/1	Single Row Male 180° DIP
				Angle			PROJ.		Type
				DIM					Customer NO.

# WCON

Http: www.wcon.com

WCON-Dongguan Tel: +86 769 85358920  
WCON-Kunshan Tel: +86 512 57468408  
Fax: +86 769 85358915  
E-mail: sales@wcon.com