

# HSF

NOTES:  
 Current Rating: 3.0AMP  
 Contact Resistance: 20mΩ Max  
 Withstand Voltage: 1000V AC  
 Insulation Resistance: 1000MΩ Min  
 Operation Temperature: -40°C to +105°C

Contact Material: Phosphor Bronze  
 Contact plating: Au Or Sn over Ni  
 Insulator Material: PA9T+33%G.F UL94V-0

Recommended P.C.B Layout(Top Side)  
 (PCB BOARD TOLERANCE ±0.05)

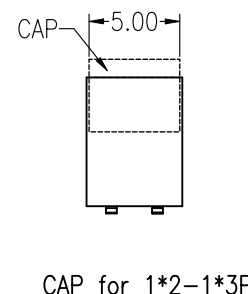
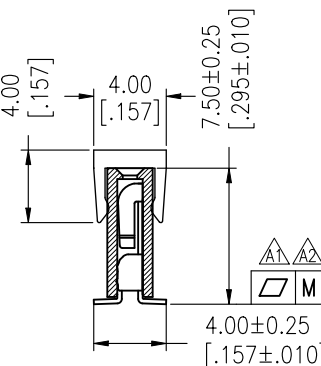
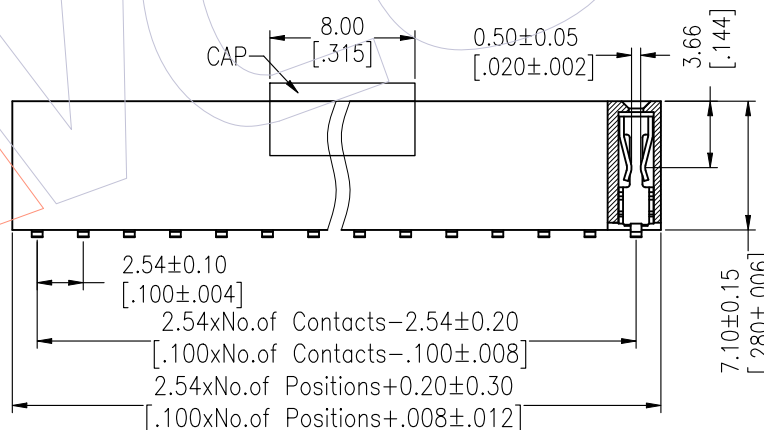
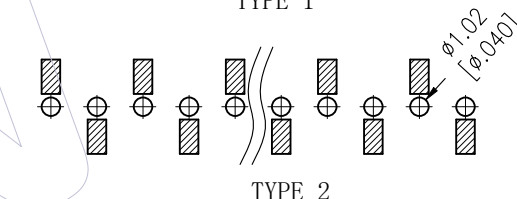
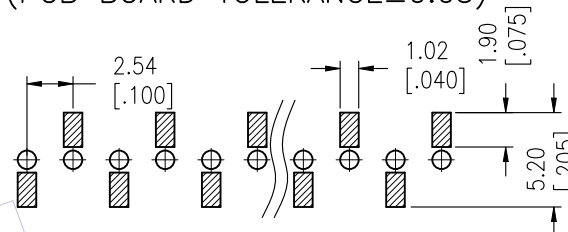
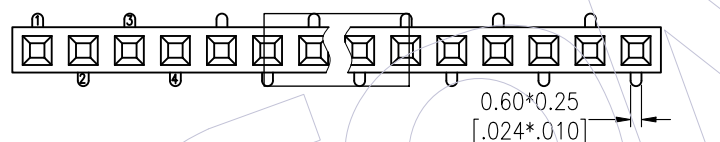
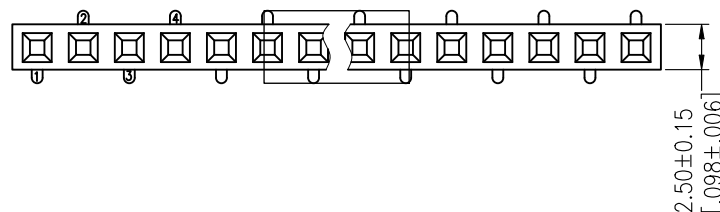

## Ordering Information

2171 - 1 XX M XX CUN X X

No. of Pins per ROW: 02-40PIN

Contact Plating:  
 G0=Gold Flash  
 G3=10μ"Gold  
 G4=15μ"Gold  
 G5=30μ"Gold  
 S0=Gold Flash/Tin  
 S3=10μ"Gold/Tin  
 S4=15μ"Gold/Tin  
 S5=30μ"Gold/Tin  
 SN=Tin  
 SM=Matte Tin

Packing:  
 T=Tube  
 P=Tube+CAP  
 R=Tape&Reel+CAP

Series No.  
 1=TYPE 1  
 2=TYPE 2

Item	Pitch	Mating
Standard	2.54	1115/1120/1125
Alternate		

Pin(Per Row)	2-15P	16-25P	26-40P
M	0.10	0.15	0.18

TITLE	PART NO.
TYPE 1	2171-1XXMXXCUNX1
TYPE 2	2171-1XXMXXCUNX2

REV	DATE	MODIFICATION DESCRIPTION	CHANGE	OPERATION	DRAW	DATE	SCALE	FIT	PART NO.
A2	2023/02/13	Modify Flatness	-----	X.X ±0.40	XSR	2023/02/13	UNIT mm		SEE TABLE
A1	2018/04/29	MODIFY P/N ; ADD DIM.	-----	X.XX ±0.25	CHECK	DATE	SIZE A4		TITLE: 2.54mm Female Header SINGLE ROW 180°SMT H=7.1
A0	2012/08/13	NEW	-----	X.XXX ±0.15	APPROVE	DATE	SHEET 1/1		Customer NO.
				Angle ± 3°			PROJ.		
				DIM TOL					

# WCON

Http: www.wcon.com

WCON-Dongguan Tel: +86 769 85358920 Fax: +86 769 85358915 E-mail: sales@wcon.com  
 WCON-Kunshan Tel: +86 512 57468408 Fax: +86 512 57468468 E-mail: salesks@wcon.com