

# HSF

NOTES:  
 Rated Current: 7.0AMP.  
 Contact Resistance: 20mΩ Max.  
 Rated Voltage: 250V  
 Operation Temperature: -40℃ to +125℃

Contact Material: Brass  
 Contact Plating: Au or Sn Over Ni  
 Insulator Body Material: PA9T UL94V-0 BK  
 Cover Material: PA9T UL94V-0 BK

## Ordering Information

73040-4 M R 034 C P S4 D A X W

4 rows  
 MALE  
 R=R/A  
 034=34P  
 C=PA9T  
 P=Brass  
 Contact Plating:  
 S4=Sel.15U" Au/Matte Sn  
 D=Ports no Sealed & Terminals Sealed  
 A=Tray Packing  
 Key Option Code  
 W=W/T WCON

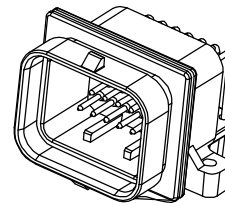
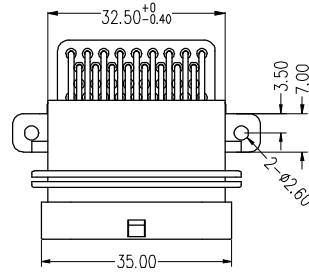

Recommended P.C.B Layout (Top Side)  
 (PCB BOARD TOLERANCE±0.05)

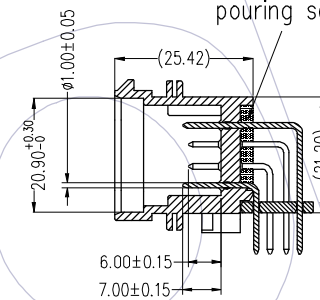
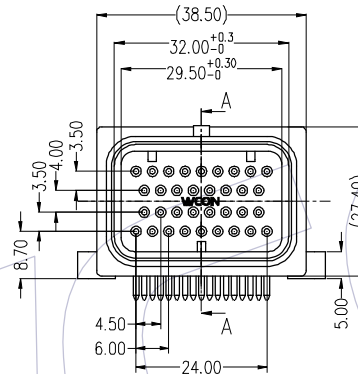
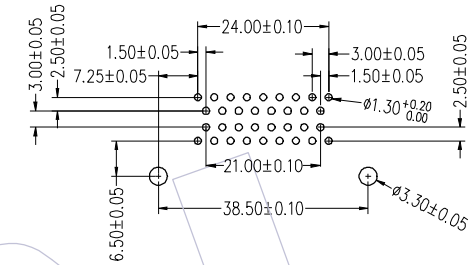

pouring sealant

SEC A-A

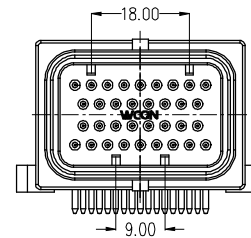
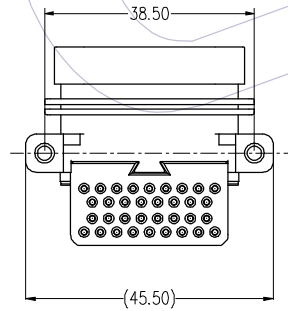
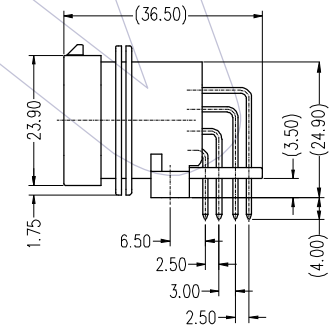

73040-4MR034CPS4DA3W

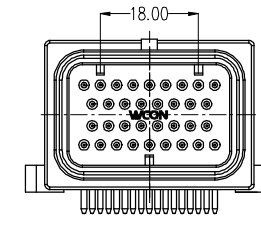

73040-4MR034CPS4DA2W

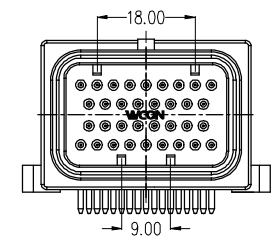

73040-4MR034CPS4DA1W

REV	DATE	MODIFICATION DESCRIPTION	CHANGE	OPERATION	DRAW	DATE	SCALE	Fit	PART NO.
				x.	±0.60	2022/09/23	UNIT	mm	73040-4MR034CPS4DAXW
				x.x	±0.40		SIZE	A4	TITLE:
				x.xx	±0.25		SHEET	1/1	3.0*4.0mm, SUPER SEAL CONN.
				Angle	± 3°		PROJ.	⌀	4 Rows, R/A Male 34P
				DIM	TOL				Customer NO.

# WCON

Http: www.wcon.com

WCON-Dongguan  
 Tel: +86 769 85358920  
 Fax: +86 769 85358915  
 E-mail: sales@wcon.com

WCON-Kunshan  
 Tel: +86 512 57468408  
 Fax: +86 512 57468468  
 E-mail: salesks@wcon.com