

HSF

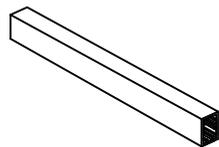

No: 1

产品装入真空管内
SG-A21 (600mm牙型真空管)

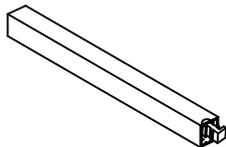
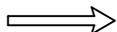

No: 2

塞塑胶塞

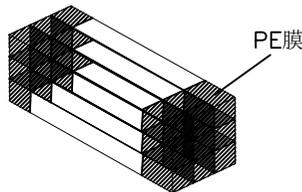
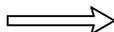

No: 3

20管为一扎(不用摆),先用PE膜固定每扎真空管两端,包住两端利角,以防划破胶袋

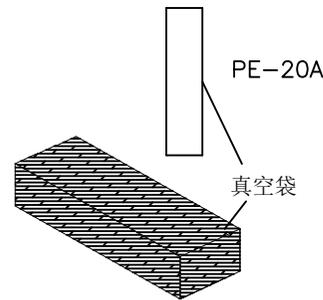

No: 4

将包扎好的真空管(3扎)装入真空袋PE-20A,外加2包干燥剂,机台抽真空



数量标签及
ROHS标签

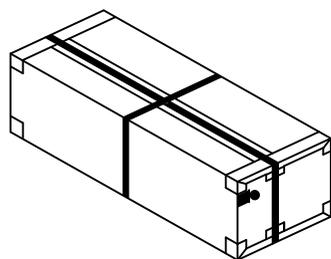

No: 8

打包装带

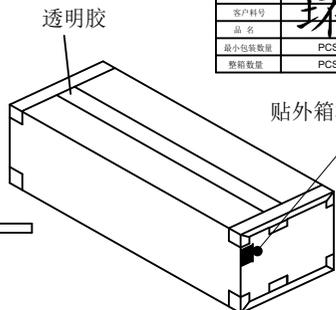

No: 7

封箱及贴标签于外箱侧面的左上角

WCON 伟峰五金电子有限公司		3	
成品标示单			
WCON料号	HSF		
客户料号	环保		
品名	PCS	日期	年 月 日
最小包装数量	PCS	制单号	



贴外箱标签及ROHS标签

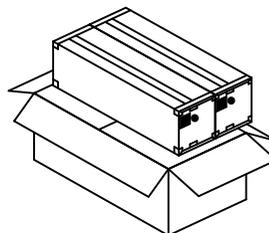

No: 6

内箱放入外箱(2内箱/外箱)
外箱规格:CTN-10C(65*33*19CM)

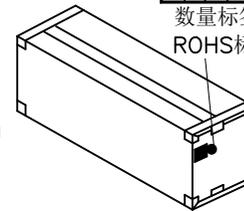

No: 5

将抽真空的产品,放入内箱.
(60管/内箱),封箱及贴标签于内箱侧面的左上角.内箱规格:CTN-10A(63*15*17CM)

1. 27*2.54牛角, 90度							
规格	真空管 装数量	每内箱 装数量	每外箱 装数量	规格	真空管 装数量	每内箱 装数量	每外箱 装数量
10P	22	1320	2640	34P	14	840	1680
12P	21	1260	2520	40P	12	720	1440
14P	20	1200	2400	44P	12	720	1440
16P	19	1140	2280	50P	11	660	1320
20P	17	1020	2040	60P	10	600	1200
24P	16	960	1920	64P	9	540	1040
26P	16	960	1920	80P	8	480	960
30P	14	840	1680	100P	6	360	720
32P	14	840	1680				

说明:

1. 产品如图所示形态放入真空管
2. 注意各标签样式,位置及方向的一致性
3. 打外箱包装带时需注意,打为十字型.

变更记事

A0	2009/12/21	NEW		
版次 REV	日期 DATE	变更说明 MODIFICATION DESCRIPTION	变更 CHANGE	核准 APPROVE

零件图	
X.	±0.50
X.X	±0.20
X.XX	±0.10
X.XXX	±0.05
Angle	
X.	± 2'
DIM	TOL

颜色 COLOR	
材质 MATERIAL	
设计 DESING	马云青
审核 CHECK	09/12/21
核准 核淮	
核准 APPROVE	

SCALE	fit
UNIT	mm
SIZE	A4
SHEET	1/1
PROJ.	

WCON

WCON Hardware Electronics Co.,Ltd

料号 PART NO. 3240-XXRXXBSTX

品名 TITLE: 1.27*2.54牛角, 90度 包装规范