

HSF

- NOTES:
- 1.Voltage Rating:125V AC/DC;
 - 2.Withstand Voltage: 1000V AC;
 - 3.Insulation Resistance: 100MΩ Min;
 - 4.Operating Temperature: -40°C to +125°C;
 - 5.Insulator Material:
PBT,G.F,UL94V-O,BK;

Matching parts	
Housing	Wiring terminal
WD2000-1HXXX001X	WD3500-TP28SN01
	WD3500-TP30SN01
	WD3500-3TP28S401
	WD3500-3TP30S401

Ordering Information

WD2000-1 H XX B O 01 X

1=Single Row

H=HOUSING

No.of Pins of single row:
04=4P; 08=8P; 10=10P;

Color:
B=Black;

PACKING:PE Bag

X Fool-proofing =01

W: With logo
blank: without logo

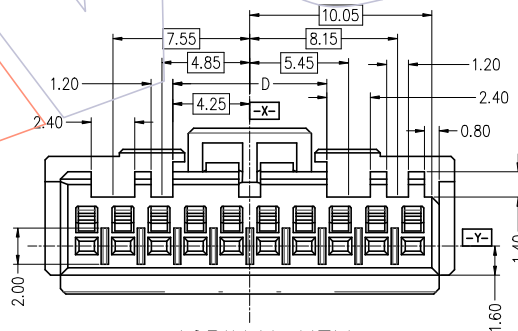
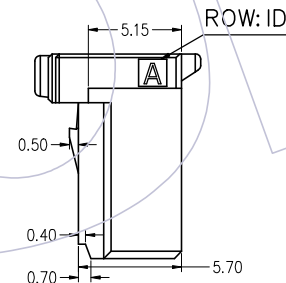
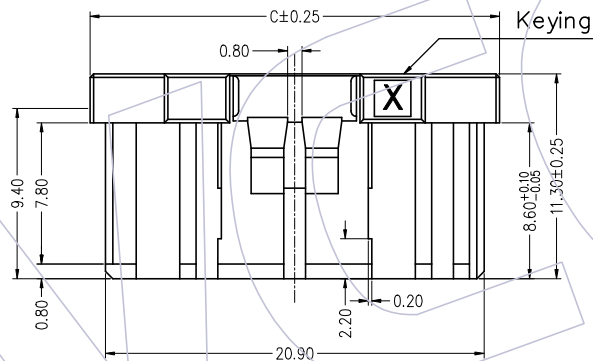
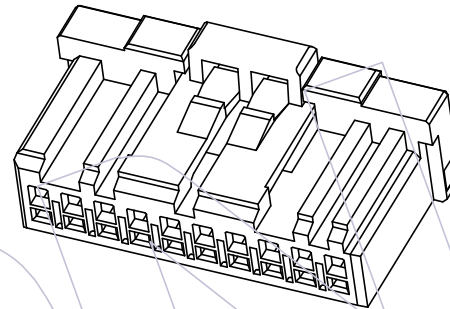
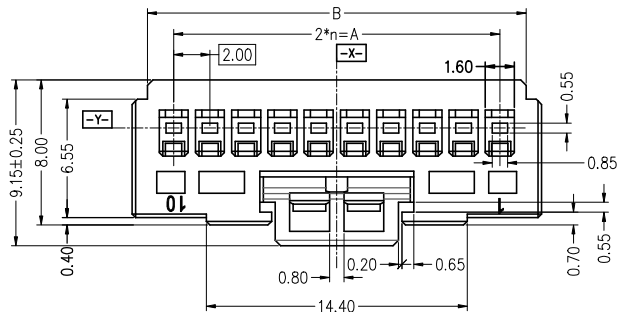

10PIN,X-KEY

WD2000-1H10B002X	10	Y	9	18.0	20.9	22.6	8.5
WD2000-1H10B001X	10	X	9	18.0	20.9	22.6	8.5
WD2000-1H08B002X	8	Y	7	14.0	16.9	18.6	8.5
WD2000-1H08B001X	8	X	7	14.0	16.9	18.6	8.5
WD2000-1H04B002X	4	Y	3	6.0	8.9	10.6	7.7
WD2000-1H04B001X	4	X	3	6.0	8.9	10.6	7.7
P/N	PIN	KEY	n	A	B	C	D

REV	DATE	MODIFICATION DESCRIPTION	CHANGE	OPERATION		DRAW kevin-xin	DATE 2023.08.02	SCALE UNIT	FIT mm	PART NO. WD2000-1HXXX0X1 (W)	 Http: www.wcon.com	
				X.X	±0.40							
A0	2023.08.02	Add the cable terminal material number	---	X.XX	±0.25	CHECK	DATE	SIZE	A4	TITLE: 2.0mm Dyn.TYPE Singel Row Socket Housing	WCON-Dongguan Tel: +86 769 85358920 Fax: +86 769 85358915 E-mail: sales@wcon.com	WCON-Kunshan Tel: +86 512 57468408 Fax: +86 512 57468468 E-mail: salesks@wcon.com
1	2022.04.20	NEW	---	X.XXX	±0.15	APPROVE	DATE	SHEET	1/3	Customer NO.		
				Angle DIM	± 3' TOL			PROJ.				

HSF

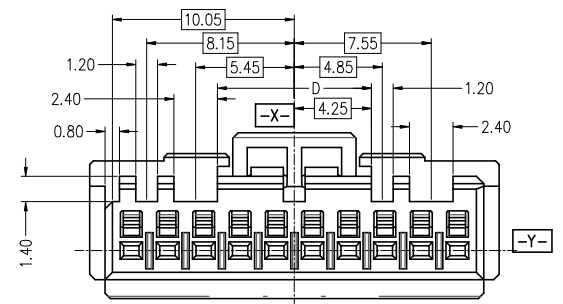
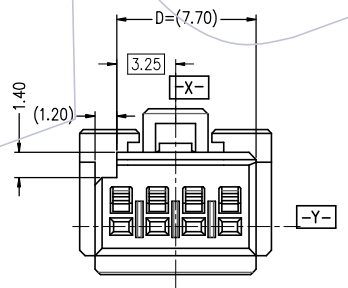
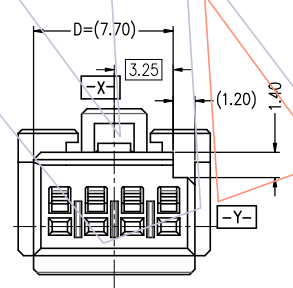
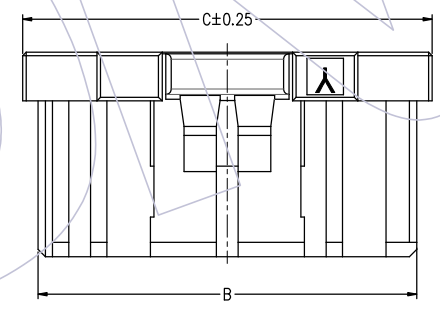
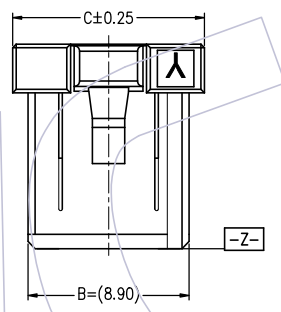
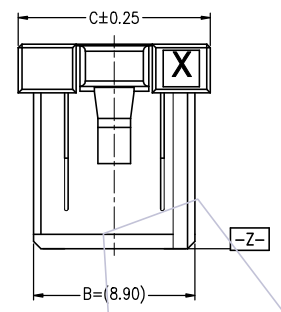
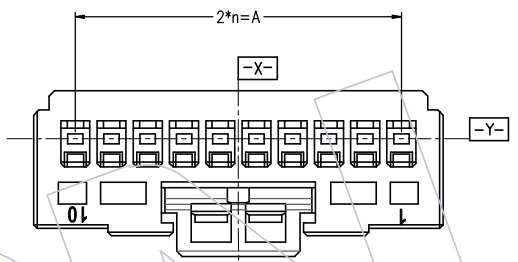
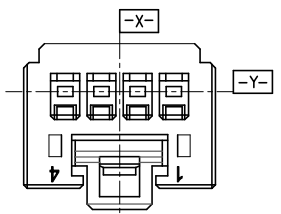
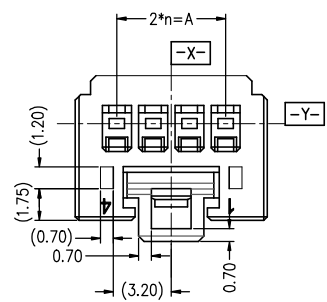

4PIN, X-KEY

4PIN, Y-KEY

10PIN, Y-KEY

REV	DATE	MODIFICATION DESCRIPTION	CHANGE
A0	2023.08.02	Add the cable terminal material number	---
1	2022.04.20	NEW	---

OPERATION	DRAW	DATE
X.X	kevin-xin	2023.08.02
X.XX	CHECK	DATE
X.XXX	APPROVE	DATE
Angle	± 3°	
DIM	TOL	

SCALE	FIT	PART NO.
UNIT	mm	WD2000-1HXXX0X1 (W)
SIZE	A4	TITLE:
SHEET	2/3	2.0mm Dyn.TYPE
PROJ.	⌀	Single Row Socket Housing
		Customer NO.

OPERATION	DRAW	DATE
X.X	kevin-xin	2023.08.02
X.XX	CHECK	DATE
X.XXX	APPROVE	DATE
Angle	± 3°	
DIM	TOL	

WCON

Http: www.wcon.com

WCON-Dongguan Tel: +86 769 85358920 Fax: +86 769 85358915 E-mail: sales@wcon.com	WCON-Kunshan Tel: +86 512 57468408 Fax: +86 512 57468468 E-mail: salesks@wcon.com
---	--

HSF

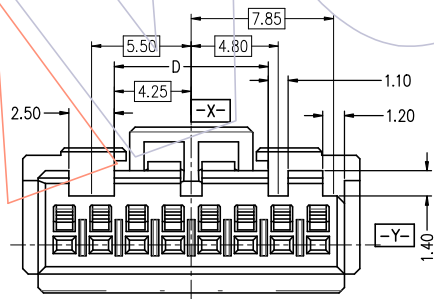
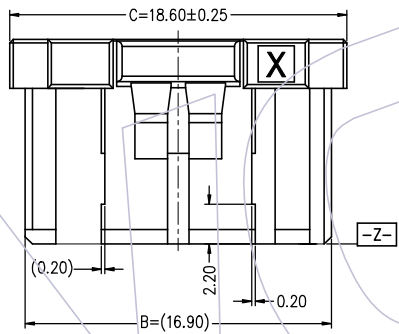
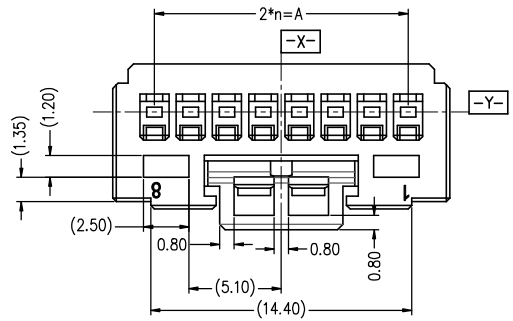

8PIN, X-KEY

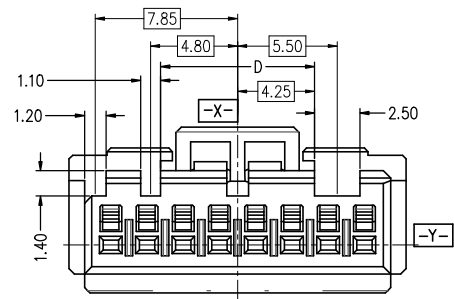
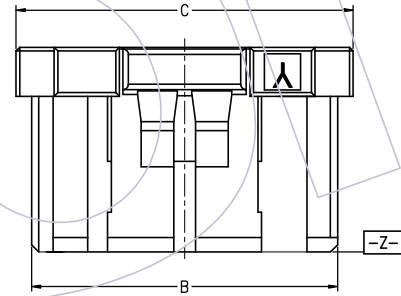
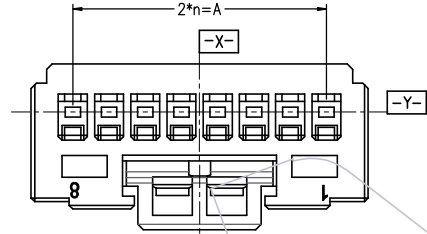

8PIN, Y-KEY

REV	DATE	MODIFICATION DESCRIPTION	CHANGE	OPERATION		DRAW kevin-xin	DATE 2023.08.02	SCALE	FIT	PART NO. WD2000-1HXXX0X1 (W)
				X.X	±0.40					
A0	2023.08.02	Add the cable terminal material number	—	X.XX	±0.25	CHECK	DATE	UNIT	mm	TITLE: 2.0mm Dyn.TYPE Single Row Socket Housing
1	2022.04.20	NEW	—	X.XXX	±0.15	APPROVE	DATE	SIZE	A4	Customer NO.
				Angle	± 3°			SHEET	3/3	
				DIM	TOL			PROJ.	⌀ ↗	

WCON

Http: www.wcon.com

WCON-Dongguan Tel: +86 769 85358920 Fax: +86 769 85358915 E-mail: sales@wcon.com	WCON-Kunshan Tel: +86 512 57468408 Fax: +86 512 57468468 E-mail: salesks@wcon.com
---	--