

HSF

28PIN,X-KEY

- NOTES:
- 1.Voltage Rating:125V AC/DC;
 - 2.Withstand Voltage: 1000V AC;
 - 3.Insulation Resistance: 100MΩ Min;
 - 4.Operating Temperature: -40°C to +125°C;
 - 5.Insulator Material:
PBT,G.F,UL94V-O,BK;

Matching parts	
Housing	Wiring terminal
WD2000-2HGXXX0XX	WD3500-MTP28XX01

Ordering Information

WD2000-2 HG XX X O X X

2=Dual Row
H=HOUSING
No.of Pins of single row:
05=5P; 11=11P;13=13P;
14=14P;16=16P;17=17P;
20=20P;
Color:
B=Black; Y=Yellow;
W=Natural; R=Red
PACKING:PE Bag
O1= X Fool-proofing
O2= Y Fool-proofing
W: With logo
blank: without logo

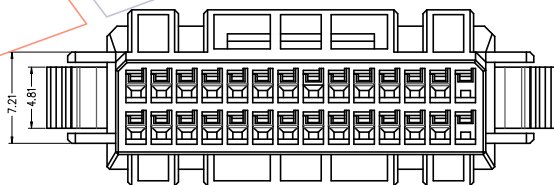
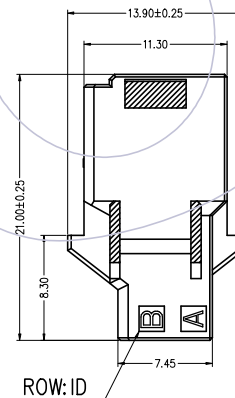
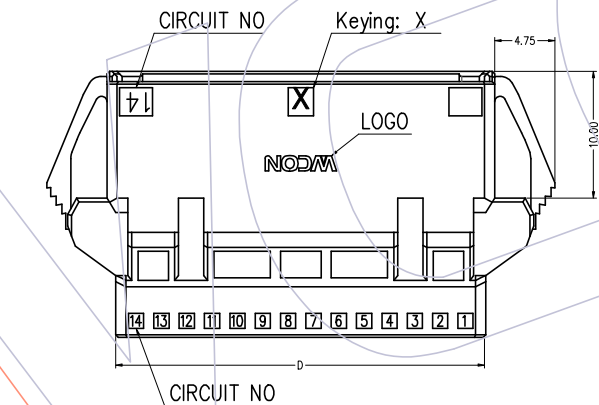
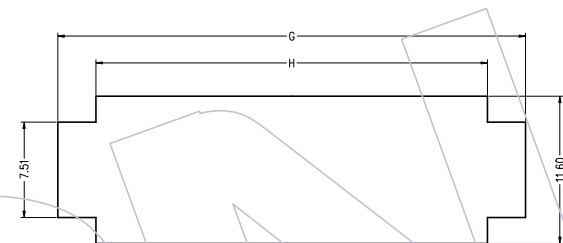
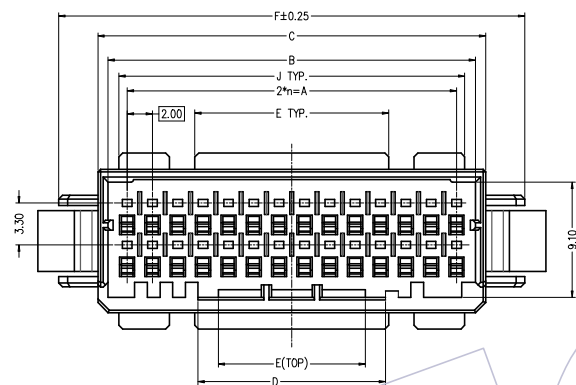

P/N	PIN	KEY	n	A	B	C	D	E	F	G	H	J
WD2000-2HG05B001X	10	X	4	See Page 4								
WD2000-2HG20B001X	40	X	19	38.00	41.00	42.60	41.20	21.30	48.78	48.9	42.9	39.3
WD2000-2HG17B001X	34	X	16	32.00	35.00	36.60	35.20	18.30	42.78	42.9	36.9	33.3
WD2000-2HG16B001X	32	X	15	30.00	33.00	34.60	33.20	17.30	40.78	40.9	34.9	31.3
WD2000-2HG14B001X	28	X	13	26.00	29.00	30.60	29.20	15.30	36.78	36.9	30.9	27.3
WD2000-2HG13B001X	26	X	12	24.00	27.00	28.60	27.20	14.30	34.78	34.9	28.9	35.3
WD2000-2HG11B001X	22	X	10	20.00	23.00	24.60	23.20	21.30	30.78	30.9	24.9	21.3

REV	DATE	MODIFICATION DESCRIPTION	CHANGE	OPERATION		DRAW kevin-xin	DATE 2023.08.02	SCALE	FIT	PART NO. WD2000-2HGXXX0X (W)	 Http: www.wcon.com	
				X.X	±0.40							
A1	2023.08.02	Add the cable terminal material number		X.XX	±0.25	CHECK	DATE	UNIT	mm	TITLE:	2. 0X3. 3mm Dyn. TYPE	
A0	2022.05.20	NEW		X.XXX	±0.15	APPROVE	DATE	SIZE	A4	Dual Row Panel Housing	WCON-Dongguan	
				Angle	± 3°					SHEET	1/4	Customer NO.
				DIM	TOL			PROJ.	⌀		Tel: +86 769 85358920	
											Tel: +86 512 57468408	
											Fax: +86 769 85358915	
											Fax: +86 512 57468468	
											E-mail: sales@wcon.com	
											E-mail: salesks@wcon.com	

HSF

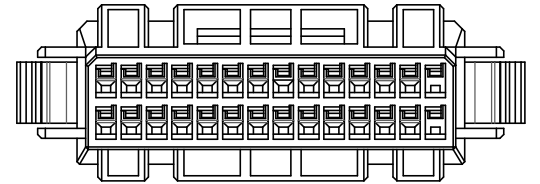
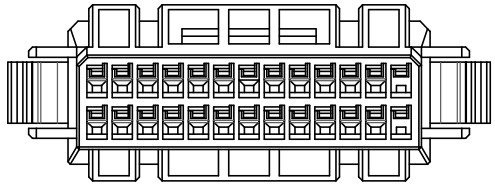
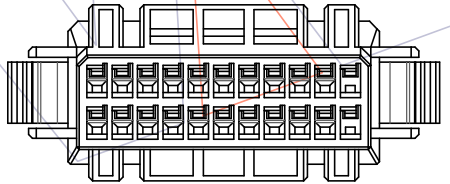
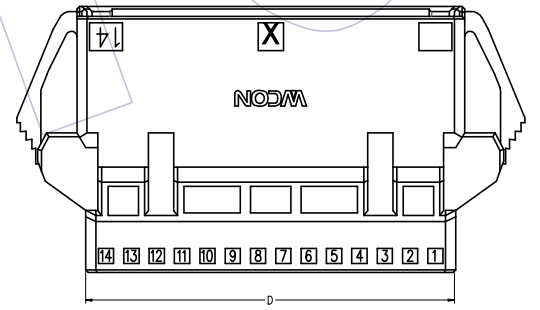
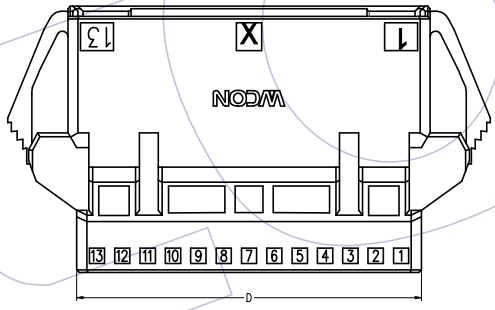
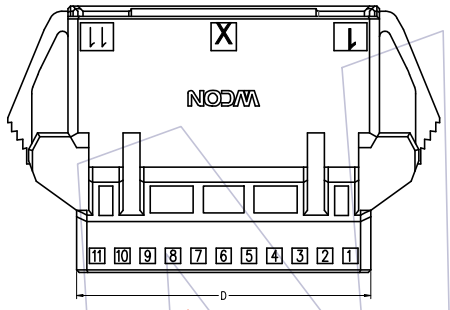
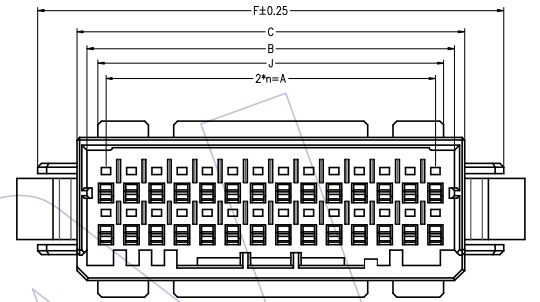
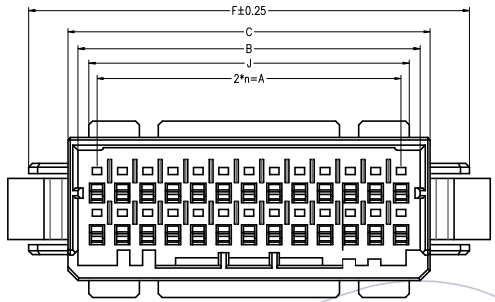
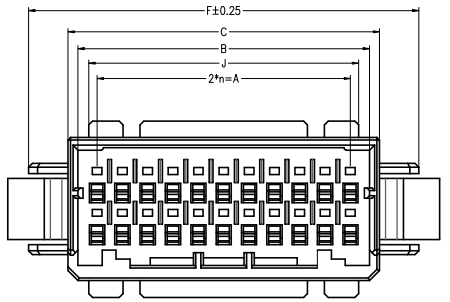

22PIN-X

26PIN-X

28PIN-X

				OPERATION	DRAW	DATE	SCALE	FIT	PART NO.	 Http: www.wcon.com WCON-Dongguan Tel: +86 769 85358920 WCON-Kunshan Tel: +86 512 57468408 Fax: +86 769 85358915 Fax: +86 512 57468468 E-mail: sales@wcon.com E-mail: salesks@wcon.com
				X.X ±0.40	kevin-xin	2023.08.02	UNIT	mm	WD2000-2HGXXX0X (W)	
A1	2023.08.02	Add the cable terminal material number	—	X.XX ±0.25	CHECK	DATE	SIZE	A4	TITLE: 2.0X3.3mm Dyn. TYPE	
A0	2022.05.20	NEW	—	X.XXX ±0.15	APPROVE	DATE	SHEET	2/4	Dual Row Panel Housing	
REV	DATE	MODIFICATION DESCRIPTION	CHANGE	Angle ± 3° DIM TOL			PROJ.	↗	Customer NO.	

HSF

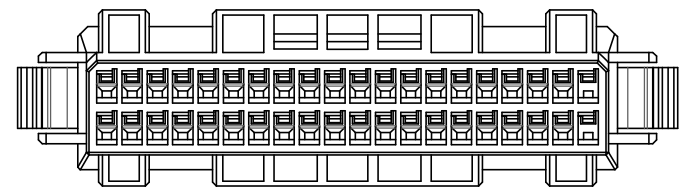
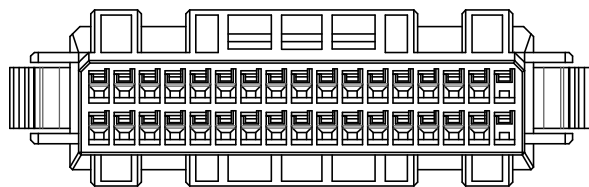
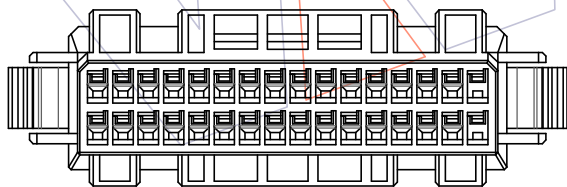
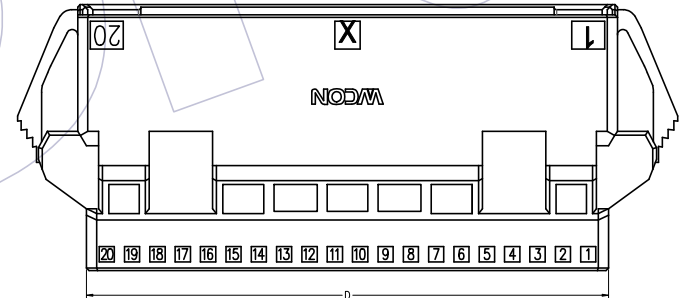
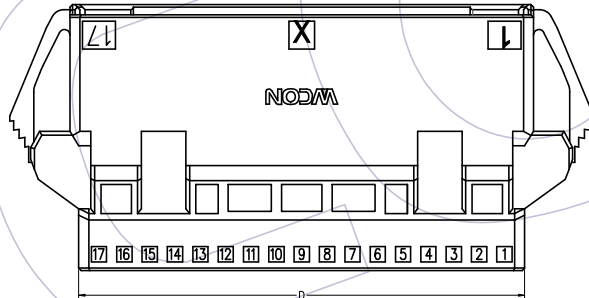
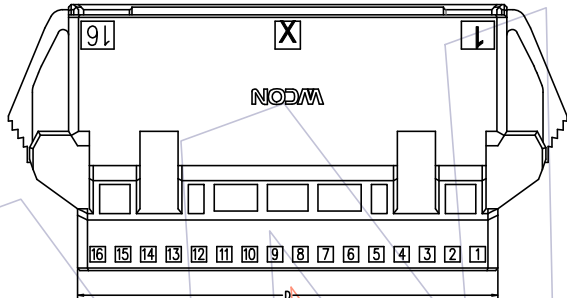
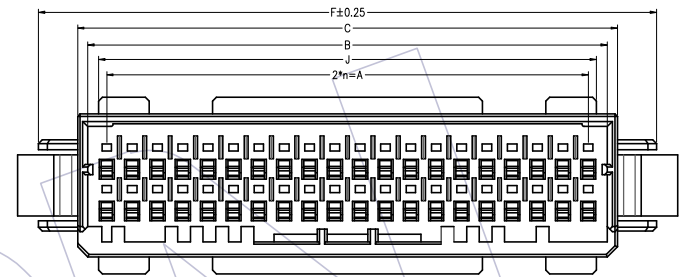
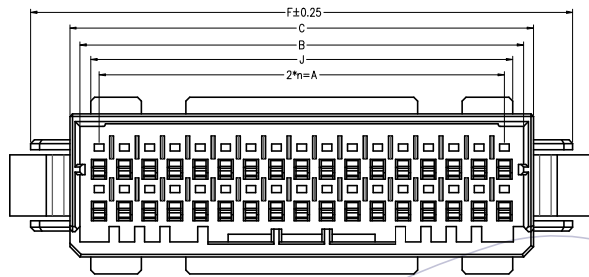
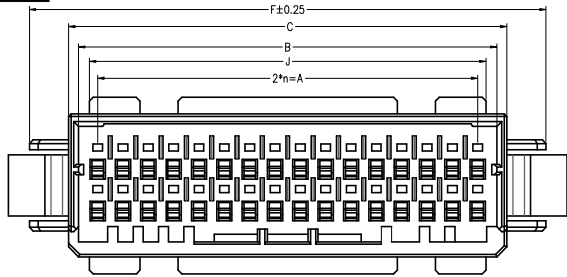

32PIN-X

34PIN-X

40PIN-X

				OPERATION	DRAW	DATE	SCALE	FIT	PART NO.	 Http: www.wcon.com
				X.X ±0.40	kevin-xin	2023.08.02	UNIT	mm	WD2000-2HGXXX0X (W)	
A1	2023.08.02	Add the cable terminal material number	—	X.XX ±0.25	CHECK	DATE	SIZE	A4	TITLE: 2.0X3.3mm Dyn. TYPE	WCON-Dongguan
A0	2022.05.20	NEW	—	X.XXX ±0.15			SHEET	3/4	Dual Row Panel Housing	Tel: +86 769 85358920
REV	DATE	MODIFICATION DESCRIPTION	CHANGE	Angle ± 3°	APPROVE	DATE	PROJ.	↻	Customer NO.	Tel: +86 512 57468408
				DIM TOL						Fax: +86 769 85358915
										E-mail: sales@wcon.com
										E-mail: salesks@wcon.com

HSF

RECOMMENDED PANEL LAYOUT
(APPLICABLE PANEL THICKNESS: 0.8,1.0,1.6,2.0)

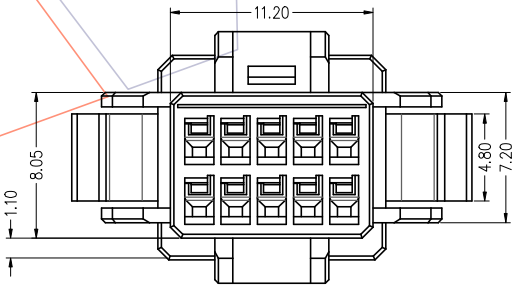
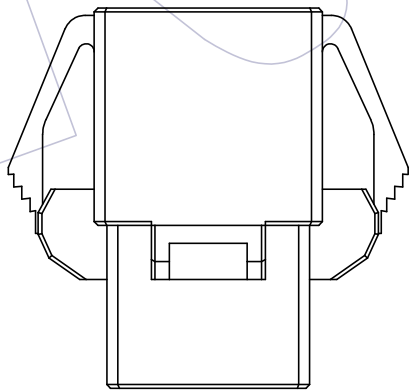
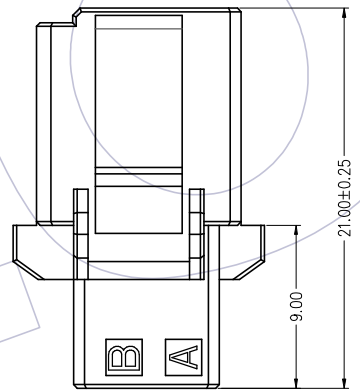
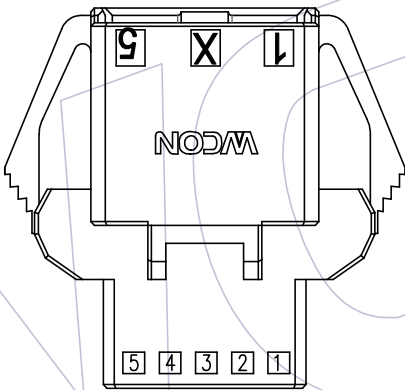
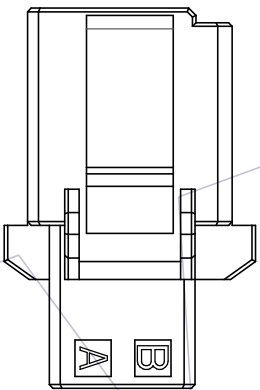
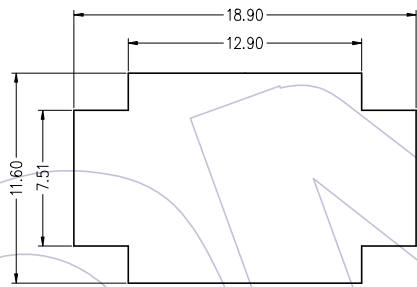
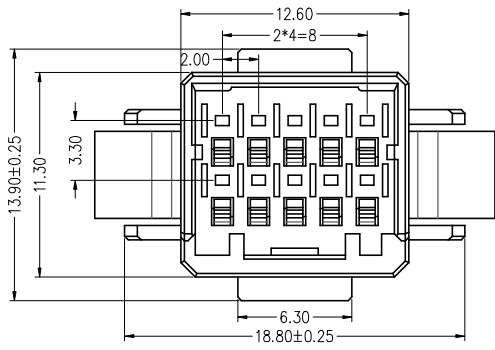

REV	DATE	MODIFICATION DESCRIPTION	CHANGE	OPERATION		DRAW kevin-xin	DATE 2023.08.02	SCALE	FIT	PART NO. WD2000-2HGXXX0X(W)	 Http: www.wcon.com	
				X.X	±0.40							
A1	2023.08.02	Add the cable terminal material number	---	X.XX	±0.25	CHECK	DATE	UNIT	mm	TITLE: 2.0X3.3mm Dyn. TYPE Dual Row Panel Housing	WCON-Dongguan	WCON-Kunshan
A0	2022.05.20	NEW	---	X.XXX	±0.15	APPROVE	DATE	SIZE	A4		Tel: +86 769 85358920	Tel: +86 512 57468408
				Angle	± 3'					SHEET	4/4	Fax: +86 769 85358915
				DIM	TOL			PROJ.	⌀ ↗	E-mail: sales@wcon.com	E-mail: salesks@wcon.com	
										Customer NO.		