

# HSF

- NOTES:
- 1.Voltage Rating: 250V AC/DC;
  - 2.Withstand Voltage: 1500V AC;
  - 3.Insulation Resistance: 100MΩ Min;
  - 4.Operating Temperature: -40°C to +125°C;
  - 5.Insulator Material: PBT,G.F,UL94V-O,BK;

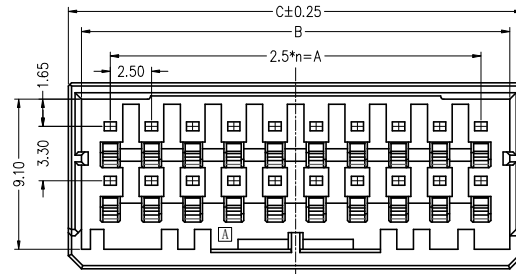

20PIN,X-KEY

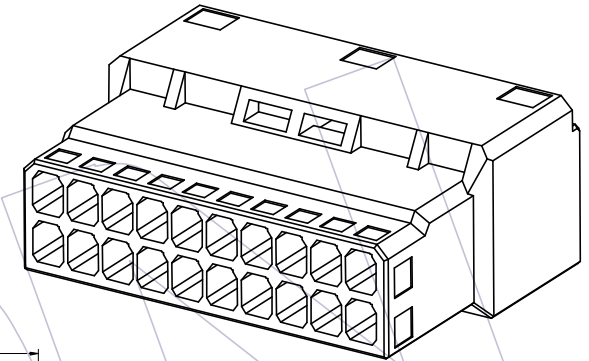

Matching parts	
Housing	Wiring terminal
WD2500-2HKXX0XX	WD3500-MTPXXS01 WD3500-MTPXXS401 XX: 18~30Awg

## Ordering Information

WD2500-2 H K XX X O X X

2=Dual Row

H=HOUSING

No.of Pins of single row:  
02=2P; 03=3P;04=4P;  
06=6P;10=10P;

Color:  
B=Black; Y=Yellow;  
W=Natural; R=Red

PACKING: PE Bag

01= X Fool-proofing  
02= Y Fool-proofing

W: With logo  
blank: without logo

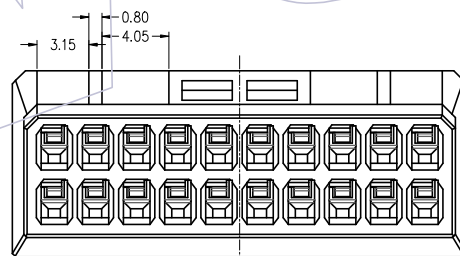
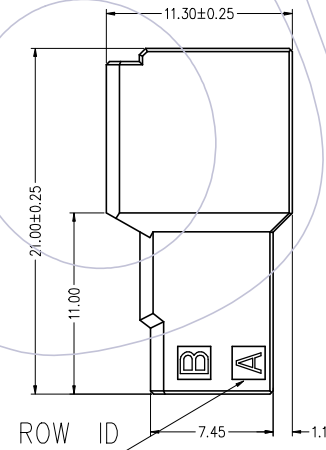
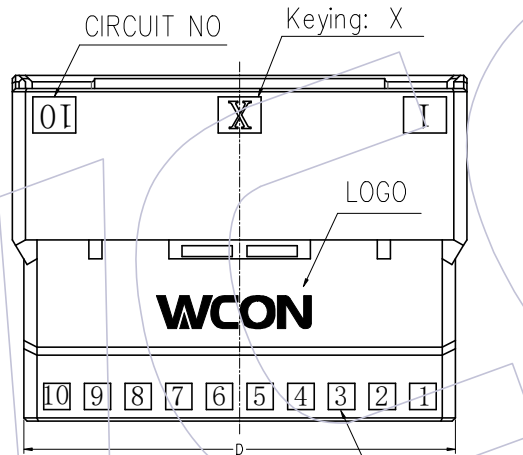

WD2500-2HK10B002(W)	20	Y	9	22.5	26.0	27.6	26.2
WD2500-2HK10B001(W)	20	X	9	22.5	26.0	27.6	26.2
WD2500-2HK06B002(W)	12	Y	5	12.5	16.0	17.6	16.2
WD2500-2HK06B001(W)	12	X	5	12.5	16.0	17.6	16.2
WD2500-2HK04B002(W)	8	Y	3	7.5	11.0	12.6	11.2
WD2500-2HK04B001(W)	8	X	3	7.5	11.0	12.6	11.2
WD2500-2HK03B002(W)	6	Y	2	5.0	8.5	10.1	8.7
WD2500-2HK03B001(W)	6	X	2	5.0	8.5	10.1	8.7
WD2500-2HK02B002(W)	4	Y	1	2.5	6.0	7.6	6.2
WD2500-2HK02B001(W)	4	X	1	2.5	6.0	7.6	6.2
P/N	PIN	KEY	n	A	B	C	D

REV	DATE	MODIFICATION DESCRIPTION	CHANGE	OPERATION		DRAW kevin-xin	DATE 2023.08.02	SCALE	FIT	PART NO. WD2500-2HKXX0X(W)
				X.X	±0.40					
A0	2023.08.02	Add the cable terminal material number	—	X.XX	±0.25	CHECK	DATE	UNIT	mm	TITLE: 2.5X3.3mm Dyn. TYPE Dual Row Free Hanging Housing
1	2022.07.06	NEW	—	X.XXX	±0.15	APPROVE	DATE	SIZE	A4	
				Angle	± 3'		DATE	SHEET	1/2	
				DIM	TOL			PROJ.	⌀	Customer NO.

# WCON

Http: www.wcon.com

WCON-Dongguan Tel: +86 769 85358920 Fax: +86 769 85358915 E-mail: sales@wcon.com

WCON-Kunshan Tel: +86 512 57468408 Fax: +86 512 57468468 E-mail: salesks@wcon.com

# HSF

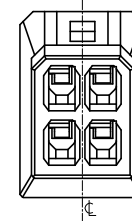
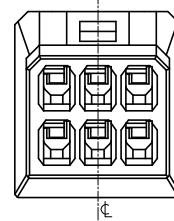
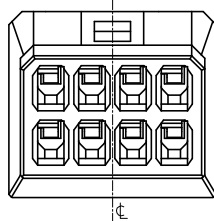
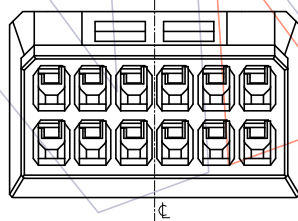
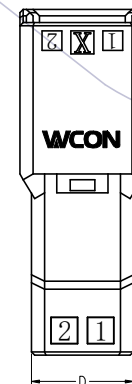
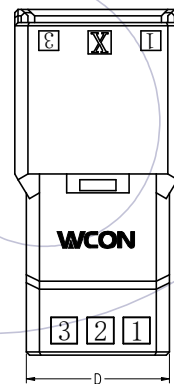
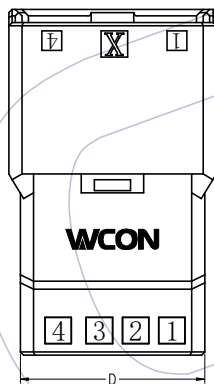
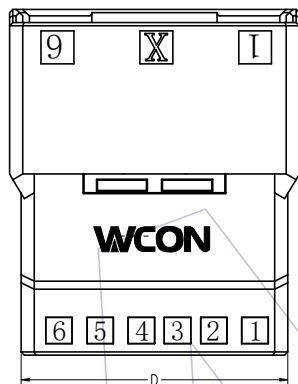
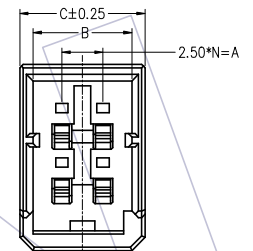
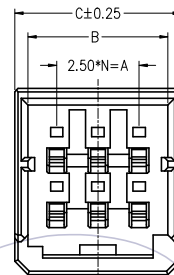
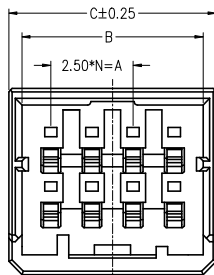
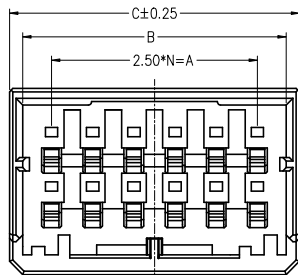

12Pin-X

8Pin-X

6Pin-X

4Pin-X

REV	DATE	MODIFICATION DESCRIPTION	CHANGE	OPERATION		DRAW kevin-xin	DATE 2023.08.02	SCALE	FIT	PART NO. WD2500-2HKXXX0X (W)	 Http: www.wcon.com	
				X.X	±0.40							
A0	2023.08.02	Add the cable terminal material number	—	X.XX	±0.25	CHECK	DATE	UNIT	mm	TITLE: 2.5X3.3mm Dyn. TYPE Dual Row Free Hanging Housing	WCON-Dongguan	
1	2022.07.06	NEW	—	X.XXX	±0.15	APPROVE	DATE	SIZE	A4		Tel: +86 769 85358920	
				Angle	± 3'				SHEET	2/2	Tel: +86 512 57468408	
				DIM	TOL			PROJ.	⌀ ↗	E-mail: sales@wcon.com		
										E-mail: salesks@wcon.com		
										Customer NO.		