

HSF

NOTES:
 Current Rating: 10A
 Voltage Rating: 300V
 Contact Resistance: 8milliohm Max
 Withstand Voltage: AC2000V
 Insulation Resistance: 1000Megohm Min
 Screw Torque: 4.4 lbf.in
 Wire range: 12-30AWG
 Operation Temperature: -40°C to +105°C

Ordering Information:

P F 508 - B XX X SM W 1 N

F=Female Pitch 508=5.08
 No. of Pins 02-24P
 Contact Plated SM=Matte Tin
 Type W=With Screw
 Blank=W/T WCON LOGO
 N=W/O WCON LOGO

Color
 A=Green
 Y=Yellow
 R=Red
 O=Orange
 U=Blue
 G=Grey(灰色429C)

13P	76.20 ±0.30	60.96 ±0.30			
12P	71.12 ±0.30	55.88 ±0.30	24P	132.08 ±0.50	116.84 ±0.50
11P	66.04 ±0.30	50.80 ±0.30	23P	127.00 ±0.50	111.76 ±0.50
10P	60.96 ±0.30	45.72 ±0.30	22P	121.92 ±0.50	106.68 ±0.50
9P	55.88 ±0.30	40.64 ±0.30	21P	116.84 ±0.50	101.60 ±0.50
8P	50.80 ±0.30	35.56 ±0.30	20P	111.76 ±0.50	96.52 ±0.50
7P	45.72 ±0.20	30.48 ±0.20	19P	106.68 ±0.40	91.44 ±0.40
6P	40.64 ±0.20	25.40 ±0.20	18P	101.60 ±0.40	86.36 ±0.40
5P	35.56 ±0.20	20.32 ±0.20	17P	96.52 ±0.40	81.28 ±0.40
4P	30.48 ±0.20	15.24 ±0.20	16P	91.44 ±0.40	76.20 ±0.40
3P	25.40 ±0.20	10.16 ±0.20	15P	86.36 ±0.40	71.12 ±0.40
2P	20.32 ±0.20	5.08 ±0.10	14P	81.28 ±0.40	66.04 ±0.40
位数	A	B	位数	A	B

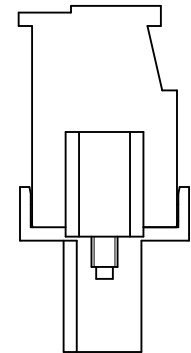

W/O WCON LOGO

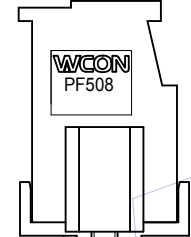

W/T WCON LOGO

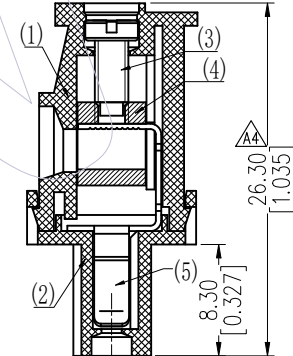
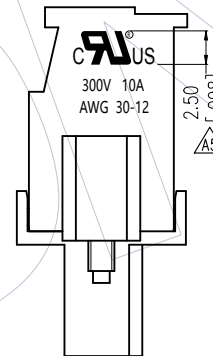
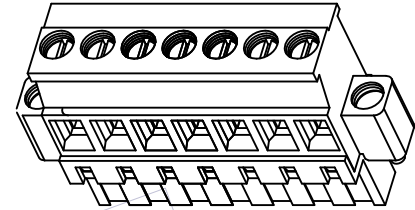
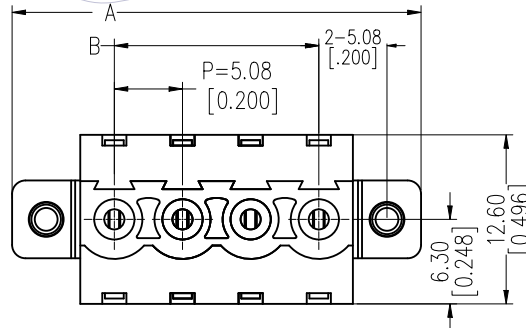
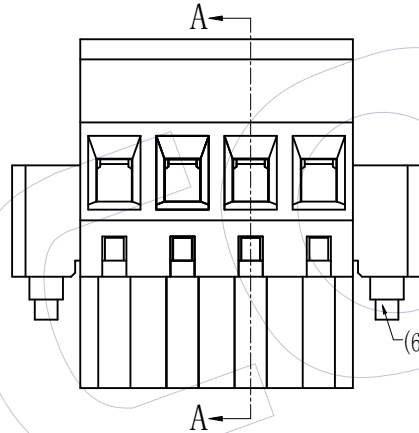
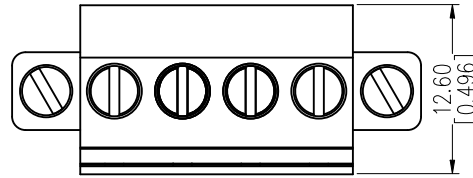

Section A-A

ITEM	品名	料号	数量	材料
(6)	Screw-2	MA025-1SNI02	N	C1018
(5)	Contact	TPT051-PSM001	N	C5191R-H T=0.4mm
(4)	Pin Block	BL025-1SNI01	N	C3604
(3)	Screw	MA025-1SXX01	N	C1018
(2)	Cover	XPF508-XXB1XN4(N)	1	PA66 UL94-V0
(1)	Housing	XPF508-XXB1XW2(N)	1	PA66 UL94-V0

REV	DATE	MODIFICATION DESCRIPTION	CHANGE	OPERATION	DRAW	DATE	SCALE	FIT	PART NO.
A5	2020/08/03	ADD UL LOGO	A5	XSR	OPERATION	2020/08/03	SCALE	FIT	MA025-1SNI02
A4	2019/06/05	Modify 26.0 to 26.30	A4	XSR	OPERATION		UNIT	mm	PF508-BXXXXSMW1(N)
A3	2018/09/12	ADD W/O LOGO P/N	A3	XSR	CHECK		INCH	A4	
A0	2011/06/08	NEW			APPROVE		SIZE	1/1	5.08mm Pitch Female Pluggable Terminal Blocks
				Angle ± 3°			SHEET		Customer NO.
				DIM TOL			PROJ.		

WCON
 Http: www.wcon.com

WCON-Dongguan Tel: +86 769 85358920
 WCON-Kunshan Tel: +86 512 57468408

Fax: +86 769 85358915
 Fax: +86 512 57468468

E-mail: sales@wcon.com
 E-mail: salesks@wcon.com